

# MB IDVERSO®

Border Management Solutions



## CHALLENGES OF GLOBALIZATION

- Increase of passenger numbers
- Preservation of highest security standards

## STATE-OF-THE-ART TECHNOLOGIES

- Automated Border Control (ABC) systems
- Next-generation eMRTDs
- Advance Passenger Information (API)
- Border management systems connected to international watch lists

## ADVANTAGES OF ABC SYSTEMS

- More efficient processing of passengers
- Cost reductions
- Increased capacities for border control
- Higher verification standards



## INTEGRATED IMMIGRATION MANAGEMENT

- Tailor-made entry / exit solution
- Based on flexible software modules
- Highest security standards

## GLOBAL INTEROPERABILITY

- Enhancement of worldwide security
- Processing of all kinds & generations of travel documents



## ELECTRONIC MACHINE-READABLE TRAVEL DOCUMENTS (eMRTDS)

Electronic ID documents accepted for traveling purposes complying with ICAO Doc. 9303

## eVISA

Efficient solution for online visa application & verification process

## VISA INFORMATION SYSTEMS (VIS)

Facilitation of visa application & of process of identification & verification

## ADVANCE PASSENGER INFORMATION (API) SYSTEMS

Submission of information on travelers to country of destination

## WATCH LISTS & DATABASES

Information systems with comprehensive databases containing relevant information



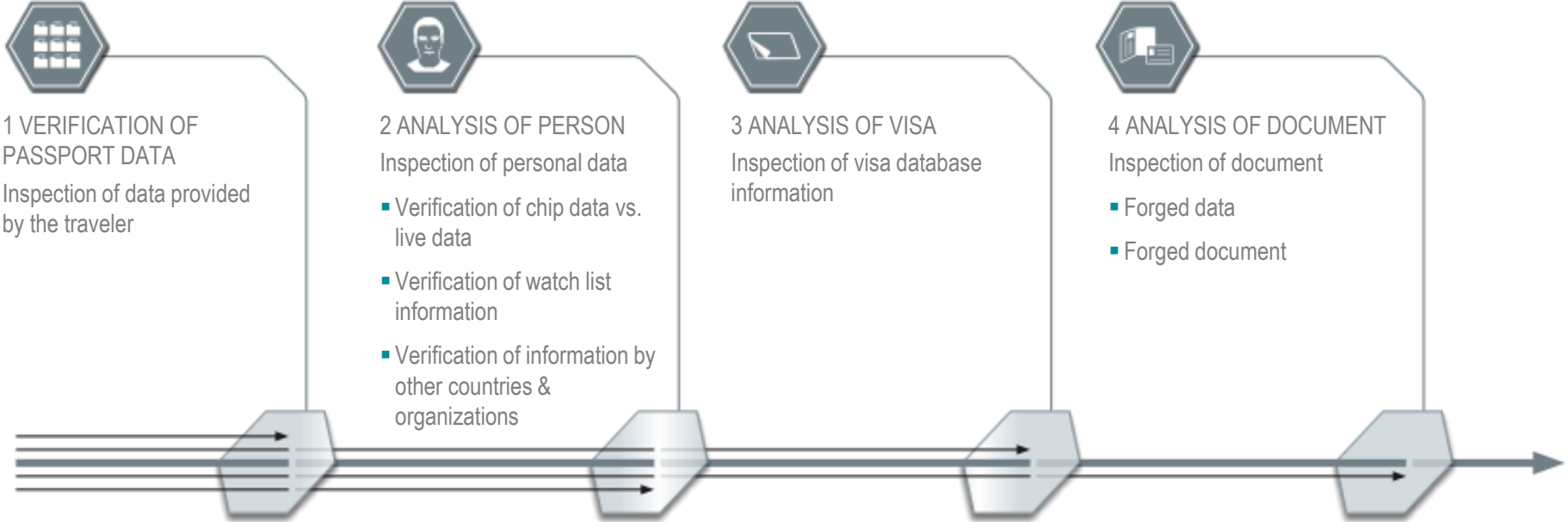

# Person & Document Identification & Verification

The screenshot shows the farrival software interface with the following sections:

- TRAVEL DOCUMENT DATA:** Document type, Document number (PN: ZP00002), Document expiry date (15/11/28), Country code (MOZ), Authority (Mozambique), Additional document number.
- PHOTO SCAN:** Document scan, Chip photo, Live face image, and a 'Capture face image' button.
- PASSPORT SCAN:** Scans for Pass (normal), Pass (infant), and Pass (U).
- FINGERPRINT SCAN:** Visual representation of hands with green dots on fingers, and individual scans for Left little, Left ring, Left middle, and Left index fingers. A 'Capture now' button is present.
- ENTRY / EXIT HISTORY:** Border crossing ID, Date, Type, Site name. Status: 'Visa is not necessary.'
  - Soplist travel document: ✓
  - Soplist Visa/Residence card: ?
  - Travel document verification: ✓ (Det)
  - Visa/Residence card verification: ?
  - Entry exit check: ✗
  - Person verification: ?
  - Person identification: ✗
  - Central server connection: ✓
- VISA/RESIDENCE CARD DATA:** Document type, Document number.
- ENTRY-EXIT DATA:** Station type, Entry, Travel mode, Vehicle number, Place of residence/hotel, Contact number, Contact person full name, Reason for traveling, Travel from, Travel to.

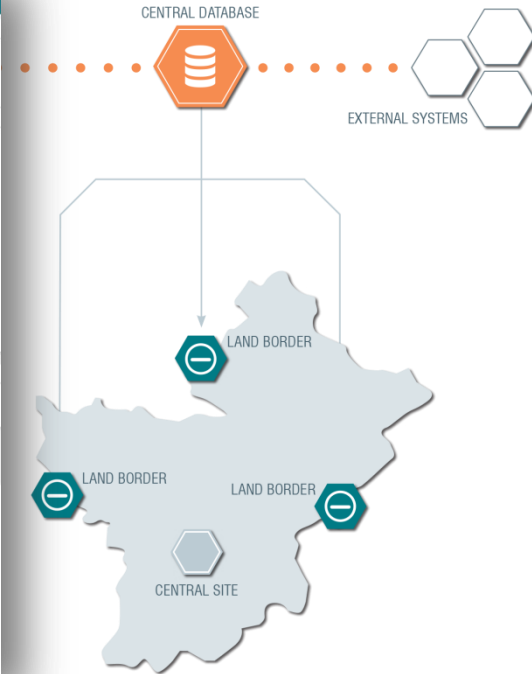

## OVERVIEW

- Turn-key Solution Provider
- Various Configurations
- Successful Operational ABC Gates
- Standards Compliant (Frontex & IATA)
- Customizable According to Requirements

Implemented in more than **5 countries** with over **8.5 million passengers** documents processed.





A row of modern, sleek fastgates and kiosks in a bright, minimalist setting. The devices are arranged in a line, receding into the distance. Each unit features a large, illuminated screen and a card reader. The design is contemporary with a mix of dark and light metallic finishes. The background consists of a large window with vertical panes, allowing natural light to illuminate the scene. The floor is a smooth, light-colored surface.

MÜHLBAUER'S  
FASTGATES & KIOSKS



# The Future of Automated Border Control

- Support of all eMRTD, ePassports, eID cards & Mobile-IDs
- Modular structure allowing for individual configurations
- Flexible integration into any environment
- High-speed multi-biometric identity verification
- Strongest international security standards
- Comprehensive verification process of individuals and documents





TCG -00:00:02:20

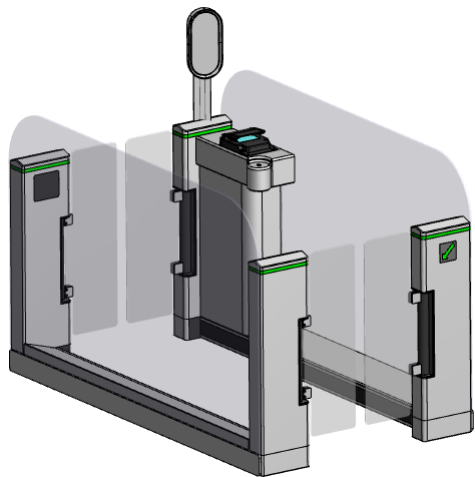

Single Step Gate

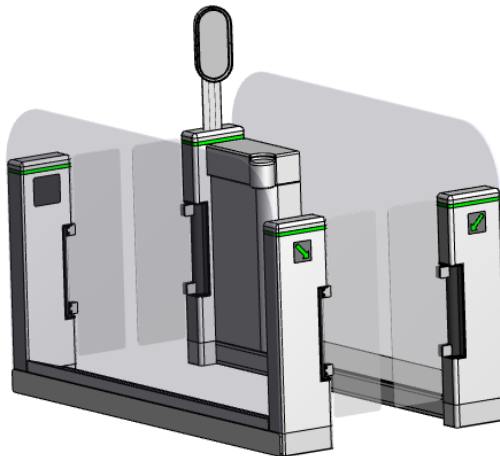

Seamless Gate

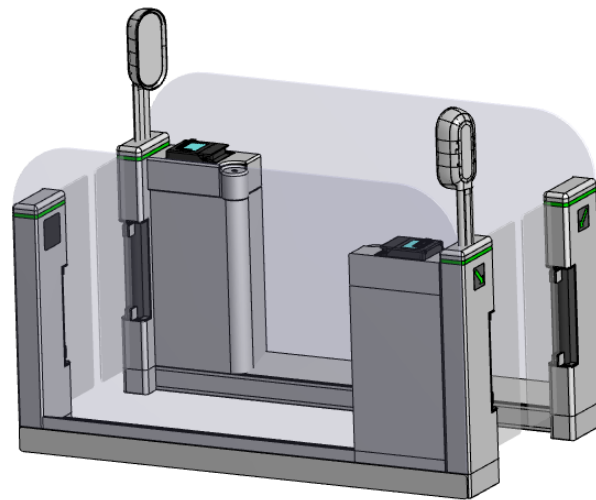

Bi-Directional Gate







## IRIS

- Reliable verification feature
- Matching of picture with enrolled data

## FACE

- Identification by use of facial biometrics
- Live-ness detection

## FINGERPRINT





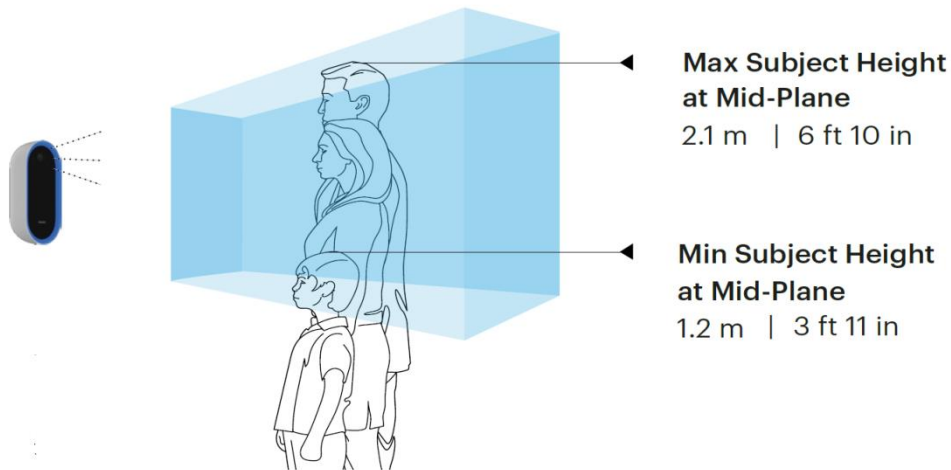

- Verification by unique pattern of fingerprint
- Single or 4-4-2 finger

## DOCUMENT READER

- ICAO standard compliant
- Passports, ID Cards, Mobile-ID



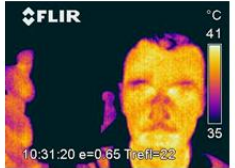

Without Manipulation		
Setup	IR image	Face camera result
		
manipulative Treatment		
Setup	IR image	Face camera result
		

Wide Angle Iris Detection

Live-ness Detection





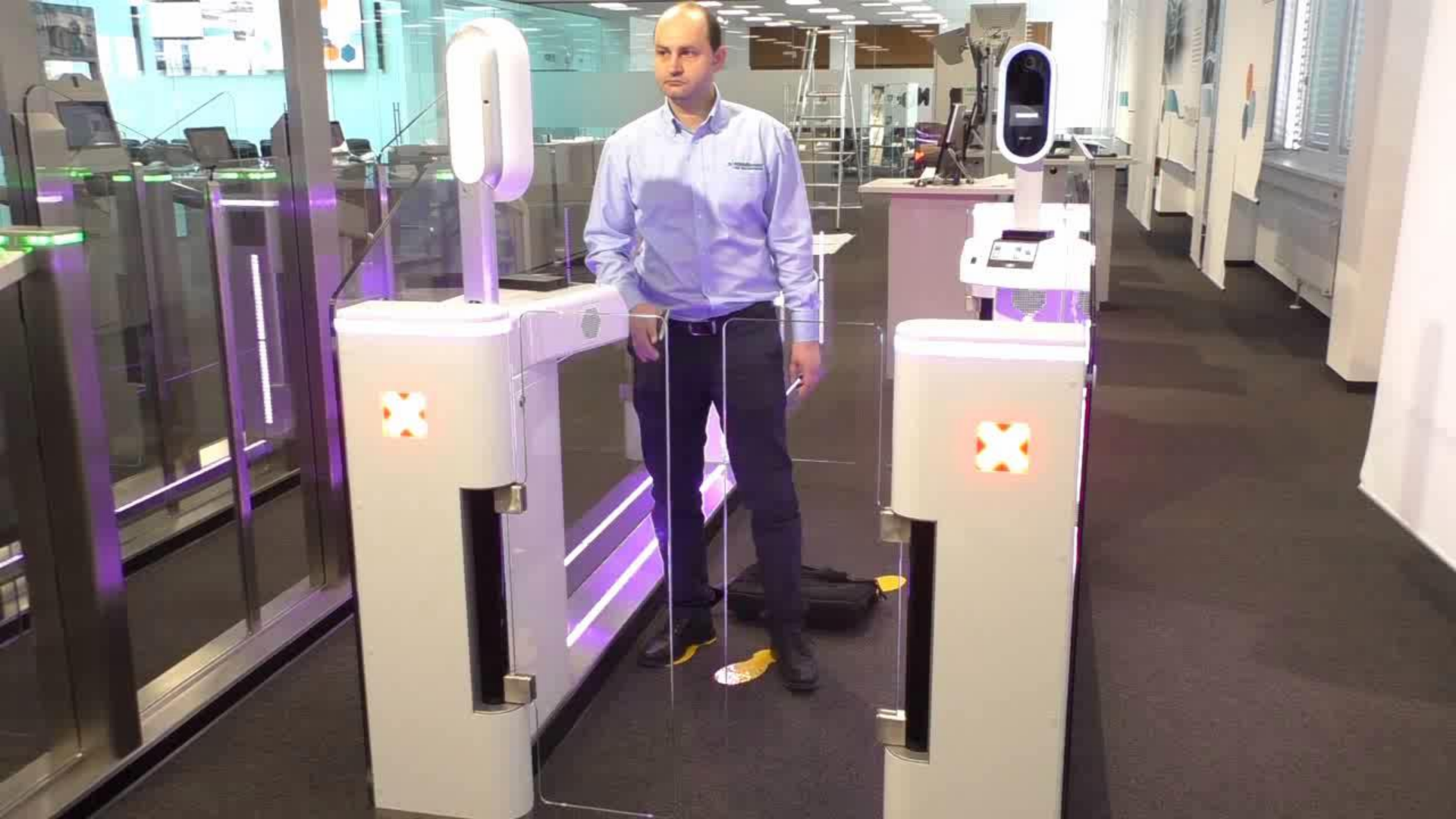

COMING SOON....

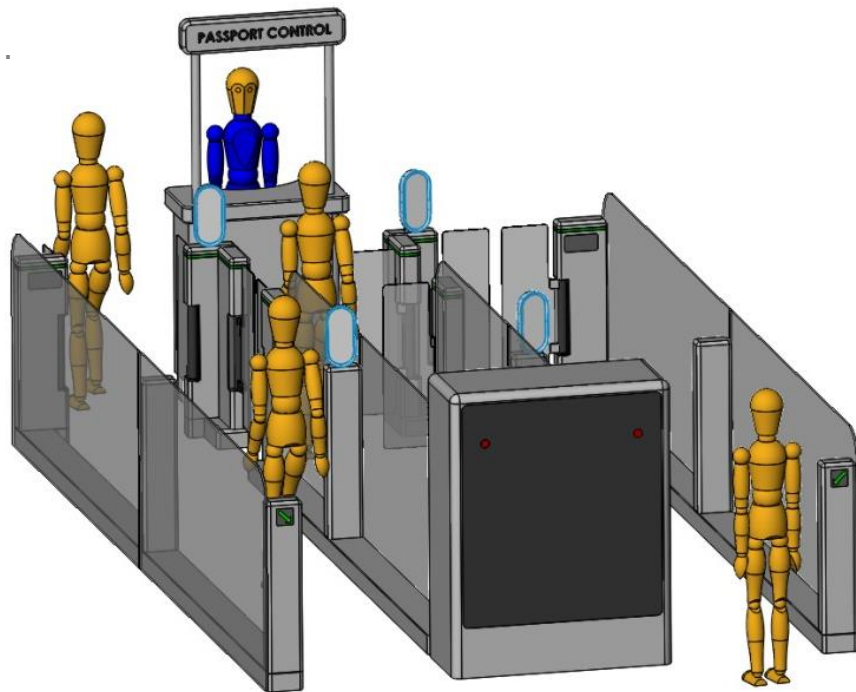

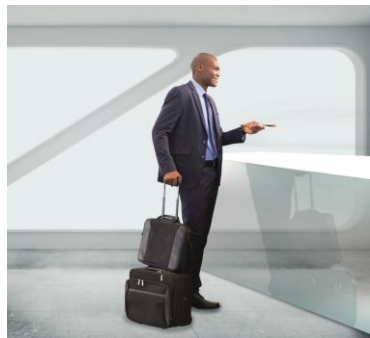

## Governmental Application Field

- Verification by police or officials
  - mobile
  - stationary
  - mixture
- also applicable at borders or other security-relevant places
  - airports
  - harbors
  - check points

## Application in Private Sector

- Verification by private instances (mobile)
  - car rental, bank/finance, HealthCare,
  - for Telecom ... and many more



## DOCUMENT VERIFICATION SOFTWARE

### Components

- Full-page eMRTD document reader
- Standard PC
  - MS Windows 7,10
  - USB ports required



PA	CSCA	AA / CA	Background
DG1	DG2	DG3	DG4
DG5	DG6	DG7	DG8
DG9	DG10	DG11	DG12
DG13	DG14	DG15	DG16
DGS00	Common	EFCardAccess	DG17
Detailed test results			

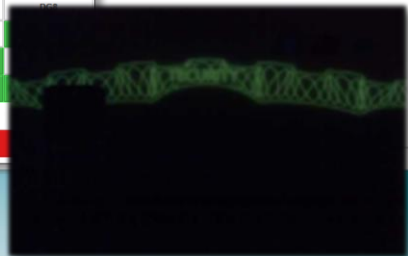

### Features

- Inspection of travel documents
  - VIZ data
  - IR/UV data
- Quality checks after personalization
- Testing of security mechanisms
  - Security feature data base
- Access to contactless chip of eDL, eMRTD
- Support of eDL ISO 18013
- Support of customer-specific chip applets
- Document verification
  - BAC / SAC / EAC / PACE CAM
- Easy and secure identification of document holder
  - Document verification against external DBs
  - Intuitive visualization of verification results
  - **Special use case: Face/Finger print verification**



### Features

- Inspection of travel documents
- Quality checks after personalization
- Testing of security mechanisms
- Access to contactless chip of eDL, eMRTD...
- Mobile and easy to use
- Intuitive mobile app user interface
- Easy and secure identification of document holder
  - built-in face matching to compare digital image on chip and live photo
  - Document verification against external databases
  - Intuitive visualization of verification results

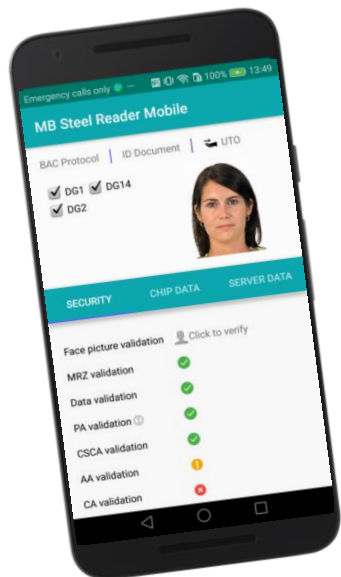





# MB Steel Reader Mobile Live Demo





# Solution Proposal according to IATA OneID initiative

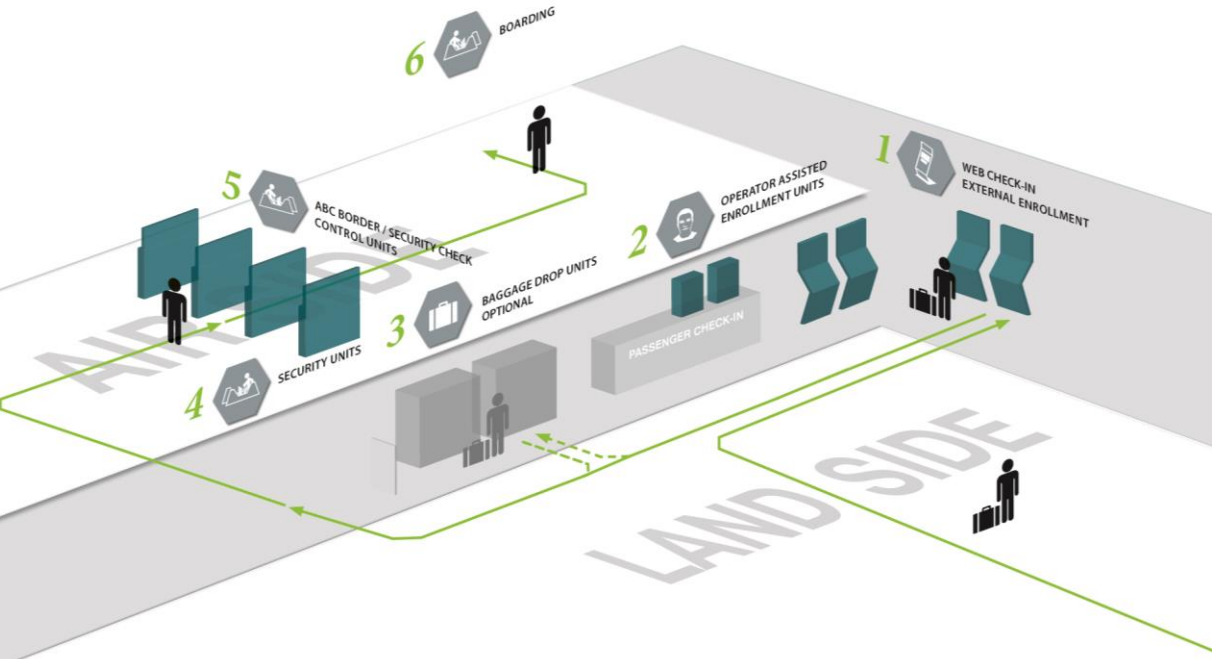

- same *touchpoints* as before
- passenger is informed & pre-checked
- passenger is identified, not intercepted
- risk is analysed beforehand
- security officer can focus on monitoring and suspect activities



MÜHLBAUER ID SERVICES GMBH  
Josef-Mühlbauer-Platz 1  
93426 Roding  
Germany

Phone: +49 9461 952 0  
Fax: +49 9461 952 1101  
Mail: [info@muehlbauer.de](mailto:info@muehlbauer.de)  
Web: [www.muehlbauer.de](http://www.muehlbauer.de)

